

## KM035R

### Kiosco de Recarga de Tarjetas

#### Kiosco de Recarga de Tarjetas

#### Características principales

- Para interior
- Multifunción
- Gabinete de acero pintado epoxi
- Monitor TFT de 10"
- Pantalla táctil SAW o capacitiva
- CPU industrial
- Procesador Intel® Quad Core (Fanless), i3, i5 o i7
- 2 o 4Gb de memoria RAM DDR3
- 32, 64 o 128 Gb de SD o 512 SATA
- Soporta OS Win 7/10, Linux

#### Opcionales

- Impresora térmica de 60 mm con autocutter
- Lector de tarjetas
- Biométrico
- Teclado industrial
- Billetero
- WiFi
- Sistema operativo Windows Embedded POSReady 7
- UPS

















#### Modelos

*KM035R*

Kiosco para recarga de tarjetas

## KM035R

## Especificaciones

Aplicación	 Transporte	Audio	 -
Ambiente	 Interior	Dimensiones	 350 x 1360 x 400 mm
Tamaño monitor	 10"	Material gabinete	 Acero SAE1010
Resolución	 1024 x 768	Espesor de chapa	 2 mm
Procesador	 Intel® Celeron® BayTrail J1900 Quad Core (2 M cache, 2.42	Terminación	 Pintura epoxi termo
RAM	 2 o 4 Gb DDR3	Alimentación	 220Vac
Almacenamiento	 32, 64 o 128 Gb SSD o	Peso	 10 Kg
Ethernet	 2 x RJ45 Gigabit	Grado protección	 IP31

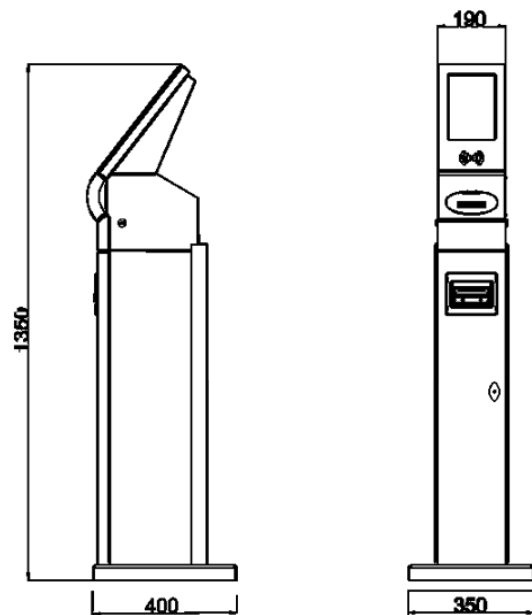

La información del documento, ilustraciones y especificaciones, son confiables a la fecha de su publicación pero está sujeta a cambios sin notificación previa.