

QS410

Q-Dispenser Elegante

Turnero digital para emisión de turnos de novedoso diseño de 17".

Características principales

- Para interior
- Monitor LCD de 17"
- Pantalla táctil Pantalla táctil SAW o capacitiva
- Procesador Intel® Quad Core tipo industrial fanless
- Conectividad Ethernet 100 BT
- Estructura de acero pintado con pintura epoxi
- Impresora térmica industrial de 60 mm con cortador automático
- Salida HDMI para pantalla informativa
- Aplicación de usuario para impresión de turnos
- Software de gestión Q-Administrator integrado en el equipo

Opcionales

- Impresora de 80 mm
- WiFi
- Licencia de Sistema Operativo Windows 10
- Panel para publicidad



















Modelos

QS410

Turnero digital para emisión de turnos elegante.

QS410

Especificaciones

Aplicación	 Servicio al cliente	Audio	 2 Parlantes x 3W
Ambiente	 Interior	Dimensiones	 328 x 1290 x 350 mm
Tamaño monitor	 17"	Material gabinete	 Acero SAE1010
Resolución	 1024 x 768	Espesor de chapa	 2 mm
Procesador	 Intel® Celeron® BayTrail J1900 Quad Core (2 M cache, 2.42	Terminación	 Pintura epoxi termo
RAM	 4 Gb DDR3 800/1066	Alimentación	 220Vac
Almacenamiento	 64 Gb SSD	Peso	 24 Kg
Ethernet	 2 x RJ45 Gigabit	Grado protección	 IP31

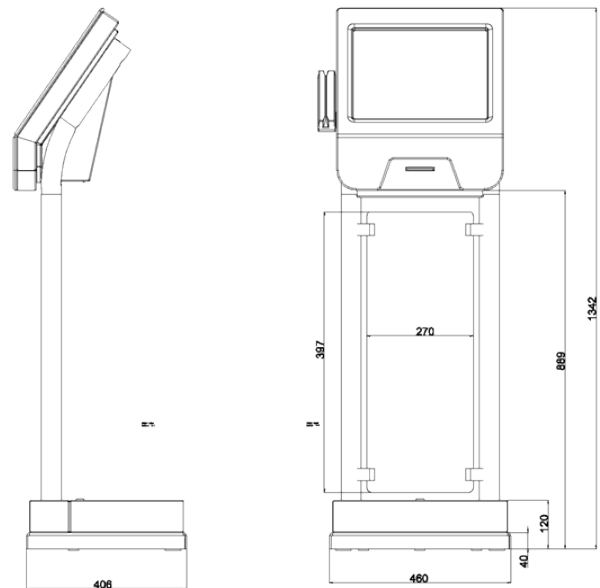

La información del documento, ilustraciones y especificaciones, son confiables a la fecha de su publicación pero está sujeta a cambios sin notificación previa.