

KM410

Kiosco multimedia NEO

NEO - Kiosco multimedia de auto consulta.

Características principales

- Para interior
- Multifunción
- Frente de plástico alto impacto
- Gabinete de acero pintado epoxi
- Monitor TFT de 17"
- Pantalla táctil SAW o capacitiva
- CPU industrial sin ventilador (Fanless)
- Procesador Intel® Quad Core , i3, i5 o i7
- 2 , 4 u 8Gb de memoria RAM DDR3
- 32, 64, 128 o 256 Gb de SD o 512 SATA
- Salida HDMI y VGA para segundo monitor
- Soporta OS Win 7/10, Linux
- Parlantes potenciados



Opcionales

- Impresora térmica de 60 u 80 mm con autocutter y/o presenter
- Lector de tarjetas
- Biométrico
- WiFi
- Sistema operativo Windows 10
- UPS
- Panel para publicidad









Modelos









KM410

Kiosco multimedia de auto consulta

KM410

Especificaciones

Aplicación	 Auto servicio
Ambiente	 Interior
Tamaño monitor	 17"
Resolución	 1280 x 1024 px
Procesador	 Intel® Celeron® BayTrail J1900 Quad Core (2 M cache, 1,99
RAM	 2, 4 u 8 Gb DDR3
Almacenamiento	 32, 64 o 128 Gb SSD o
Ethernet	 2 x RJ45 Gigabit

Audio	 2 Parlantes x 3W
Dimensiones	 328 x 1290 x 350 mm
Material gabinete	 Acero SAE1010
Espesor de chapa	 2 mm
Terminación	 Pintura epoxi termo
Alimentación	 220Vac ~ 30W
Peso	 24 Kg
Grado protección	 IP31

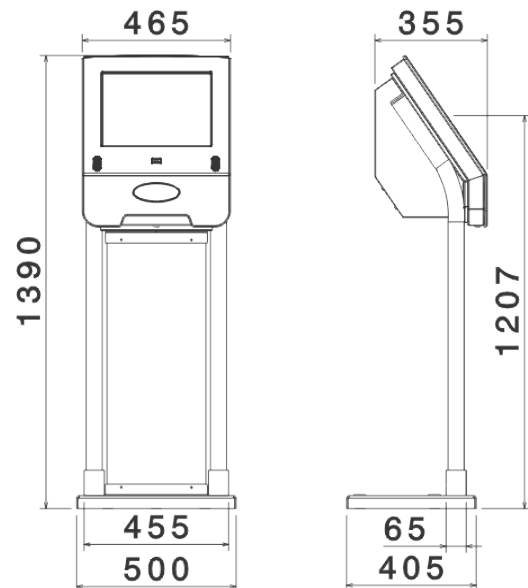

La información del documento, ilustraciones y especificaciones, son confiables a la fecha de su publicación pero está sujeta a cambios sin notificación previa.