

KM021

Kiosco multimedia CONCEPT

CONCEPT - Kiosco multimedia de auto servicio.

Características principales

- Para interior
- Multifunción
- Gabinete de acero pintado epoxi
- Monitor TFT de 21" wide
- Pantalla táctil SAW o capacitiva
- CPU industrial
- Procesador Intel® Quad Core (Fanless), i3, i5 o i7
- 2, 4 u 8Gb de memoria RAM DDR3
- 32, 64, 128 o 256 Gb de SD o 512 SATA
- Salida HDMI y VGA para segundo monitor
- Soporta OS Win 7/10, Linux
- Parlantes potenciados

Opcionales

- Impresora térmica de 60 u 80 mm con autocutter y/o presenter
- Lector de tarjetas
- Biométrico
- Billetero
- WiFi
- Sistema operativo Windows 10
- UPS

















Modelos

<i>KM017</i>	Kiosco de auto servicio de 17" CONCEPT
<i>KM019</i>	Kiosco de auto servicio de 19" CONCEPT
<i>KM021</i>	Kiosco de auto servicio de 21" CONCEPT



KM021

Especificaciones

Aplicación	 Auto servicio	Audio	 2 Parlantes x 3W
Ambiente	 Interior	Dimensiones	 450 x 1470 x 450 mm
Tamaño monitor	 17"/19"/21"	Material gabinete	 Acero SAE1010
Resolución	 1280 x 1024	Espesor de chapa	 2 mm
Procesador	 Intel® Celeron® BayTrail J1900 Quad Core (2 M cache, 1,99	Terminación	 Pintura epoxi termo
RAM	 2 o 4 Gb DDR3	Alimentación	 220Vac ~ 30W
Almacenamiento	 32, 64 o 128 Gb SSD o	Peso	 52 Kg
Ethernet	 2 x RJ45 Gigabit	Grado protección	 IP31

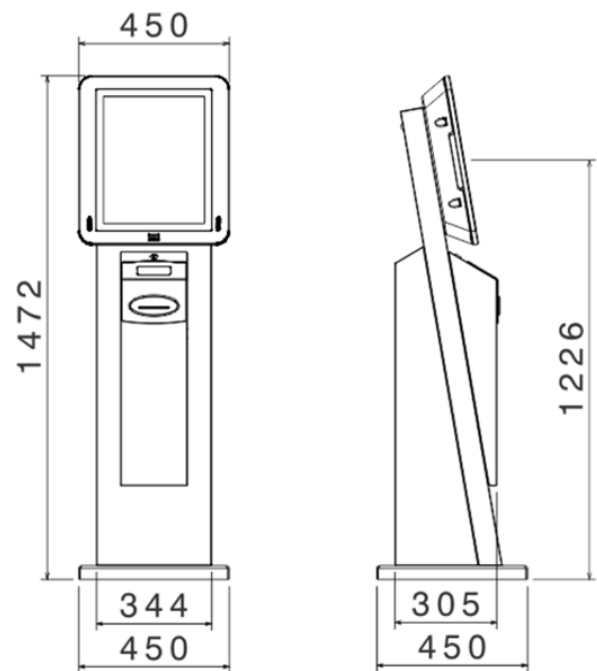

La información del documento, ilustraciones y especificaciones, son confiables a la fecha de su publicación pero está sujeta a cambios sin notificación previa.