

KM200

Kiosco elegante

Kiosco multimedia de auto consulta o auto servicio de novedoso diseño.

Características principales

- Para interior
- Multifunción
- Estructura tubular y marco de acero inoxidable
- Gabinete de acero pintado epoxi
- Frente de acrílico iluminado
- Monitor TFT de 15" o 17"
- Pantalla táctil SAW o capacitiva
- CPU industrial
- Procesador Intel® Quad Core (Fanless), i3, i5 o i7
- 2 o 4Gb de memoria RAM DDR3
- 32, 64 o 128 Gb de SD o 512 SATA
- Soporta OS Win 7/10, Linux

Opcionales

- Impresora térmica de 60 u 80 mm con autocutter y/o presenter
- Lector de tarjetas
- Biométrico
- Teclado industrial
- Billetero
- WiFi
- Sistema operativo Windows Embedded POSReady 7
- UPS

Modelos

















KM200

Kiosco multifunción de auto servicio



KM200

Especificaciones

| | | | |
|----------------|---|-------------------|---|
| Aplicación |  Auto consulta | Audio |  - |
| Ambiente |  Interior | Dimensiones |  480 x 1342 x 406 mm |
| Tamaño monitor |  15" - 17" | Material gabinete |  Acero SAE1010 |
| Resolución |  1024 x 768 | Espesor de chapa |  2 mm |
| Procesador |  Intel® Celeron® BayTrail J1900 Quad Core (2 M cache, 2.42 | Terminación |  Pintura epoxi termo |
| RAM |  2 o 4 Gb DDR3 | Alimentación |  220Vac |
| Almacenamiento |  32, 64 o 128 Gb SSD o | Peso |  10 Kg |
| Ethernet |  2 x RJ45 Gigabit | Grado protección |  IP31 |

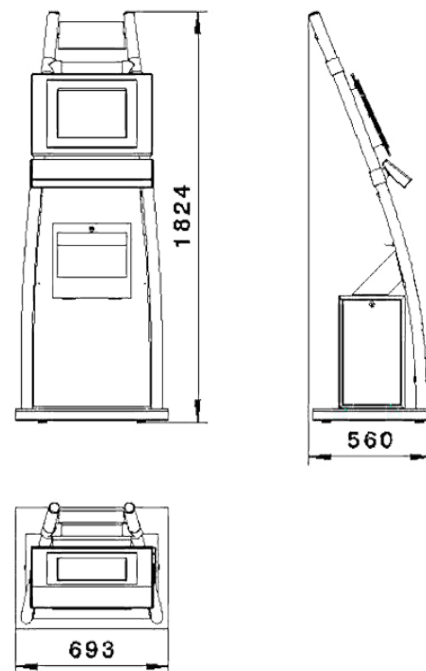

La información del documento, ilustraciones y especificaciones, son confiables a la fecha de su publicación pero está sujeta a cambios sin notificación previa.