

## KM150

Kiosco estrecho de 15"

Kiosco multimedia de auto consulta con frente de acrílico iluminado.

### Características principales

- Para interior
- Multifunción
- Gabinete de acero pintado epoxi
- Frente de acrílico iluminado
- Marco de acero inoxidable
- Monitor TFT de 15"
- Pantalla táctil SAW o capacitiva
- CPU industrial
- Procesador Intel® Quad Core (Fanless), i3, i5 o i7
- 2 o 4Gb de memoria RAM DDR3
- 32, 64 o 128 Gb de SD o 512 SATA
- Soporta OS Win 7/10, Linux

### Opcionales

- Impresora térmica de 60 u 80 mm con autocutter y/o presenter
- Lector de tarjetas
- Biométrico
- WiFi
- Sistema operativo Windows Embedded POSReady 7
- UPS

### Modelos

















*KM150*

Kiosco multimedia de auto consulta de 15" con frente de acrílico iluminado.



# KM150

## Especificaciones

Aplicación	 Auto consulta	Audio	 -
Ambiente	 Interior	Dimensiones	 520 x 1396 x 580 mm
Tamaño monitor	 15"	Material gabinete	 Acero SAE1010
Resolución	 1024 x 768	Espesor de chapa	 2 mm
Procesador	 Intel® Celeron® BayTrail J1900 Quad Core (2 M cache, 2.42	Terminación	 Pintura epoxi termo
RAM	 2 o 4 Gb DDR3	Alimentación	 220Vac
Almacenamiento	 32, 64 o 128 Gb SSD o	Peso	 10 Kg
Ethernet	 2 x RJ45 Gigabit	Grado protección	 IP31

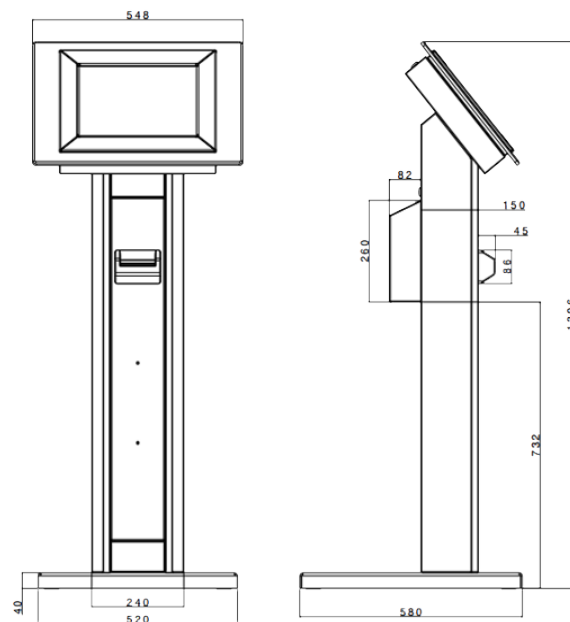

La información del documento, ilustraciones y especificaciones, son confiables a la fecha de su publicación pero está sujeta a cambios sin notificación previa.