

## KM055

### Kiosco estándar multifunción

Kiosco multimedia de auto servicio estándar.

#### Características principales

- Para interior
- Multifunción
- Gabinete de acero pintado epoxi
- Monitor TFT de 17"
- Pantalla táctil SAW o capacitiva
- CPU industrial
- Procesador Intel® Quad Core (Fanless), i3, i5 o i7
- 2 o 4Gb de memoria RAM DDR3
- 32, 64 o 128 Gb de SD o 512 SATA
- Soporta OS Win 7/10, Linux
- Parlantes potenciados

#### Opcionales

- Impresora térmica de 60 u 80 mm con autocutter y/o presenter
- Lector de tarjetas
- Biométrico
- Teclado industrial
- Billetero
- WiFi
- Sistema operativo Windows Embedded POSReady 7
- UPS

#### Modelos

















*KM055*

Kiosco estándar multifunción de auto servicio



# KM055

## Especificaciones

|                |   |                   |   |
|----------------|---|-------------------|---|
| Aplicación     |  Auto servicio   | Audio             |  2 Parlantes x 3W    |
| Ambiente       |  Interior  | Dimensiones       |  580 x 1450 x 520 mm |
| Tamaño monitor |  17"   | Material gabinete |  Acero SAE1010       |
| Resolución     |  1024 x 768  | Espesor de chapa  |  2 mm                |
| Procesador     |  Intel® Celeron®<br>BayTrail J1900 Quad<br>Core (2 M cache, 2.42 | Terminación       |  Pintura epoxi termo |
| RAM            |  2 o 4 Gb DDR3   | Alimentación      |  220Vac              |
| Almacenamiento |  32, 64 o 128 Gb SSD o   | Peso              |  10 Kg               |
| Ethernet       |  2 x RJ45 Gigabit  | Grado protección  |  IP31                |

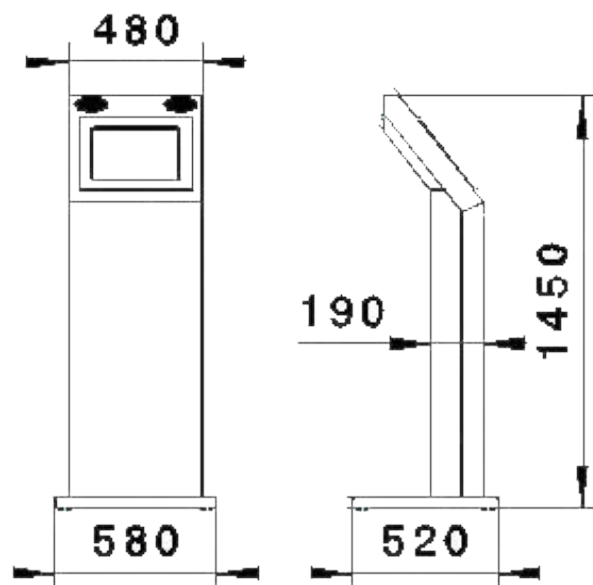

La información del documento, ilustraciones y especificaciones, son confiables a la fecha de su publicación pero está sujeta a cambios sin notificación previa.