

SR230

IPC Box i3

Computador industrial i3 embebido en gabinete de aluminio.

Características principales

- PC Industrial
- Gabinete de aluminio
- Alta resistencia a golpes y vibraciones
- CPU Intel i3
- 2 o 4Gb de memoria RAM DDR3
- Disco de 32, 64 o 128 Gb de SD o 512 SATA
- Soporta OS Win 7/10, Linux
- 4xUSB2.0, 4xCOM, 2xGbE LAN
- 8-bits I/O digitales
- Salidas HDMI y DVI
- Salida de audio potenciada
- Indicadores de encendido
- Alimentación 12Vdc



Opcionales

- WI-FI
- Rango extendido de operación
- Soporte adaptador
- Windows Embedded POSReady 7

















Modelos

SR230
SR230E

Computador Industrial Embebido - IPC Box
Computador Industrial Embebido - IPC Box, rango extendido

SR230

Especificaciones

Procesador	 2nd Generation i3 Intel	Ventilación	 Forzada
RAM	 2 Gb DDR3 800/1066	Alimentación	 12Vdc
Almacenamiento	 32 Gb de disco estado	Certificaciones	 CE, FCC Class A
Video	 1 x HDMI-A / 1 x VGA	Material gabinete	 Aluminio
Ethernet	 2 x RJ45 Gigabit	Dimensiones	 57mm x 200mm x
USB	 4 x USB 2.0	Peso	 1 Kg
Puertos COM	 4 x DB9 - RS232	Grado protección	 IP31
Entradas / Salidas	 1 x DB9 - 8 bits I/O	Temp. operación	 0°C ~ 60°C
Audio	 1 x Salida estereo 3W	Temp. de almacén	 -10°C ~ 65°C
SO soportados	 Win 7/8 - 32/64 bits	Humedad relativa	 95% sin condensación

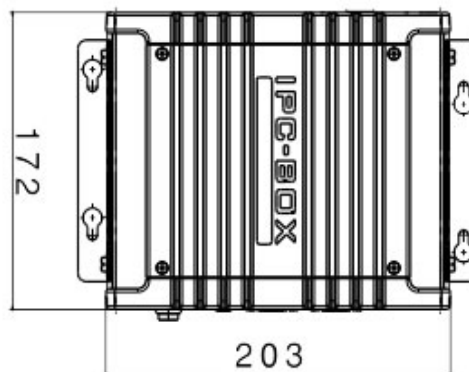
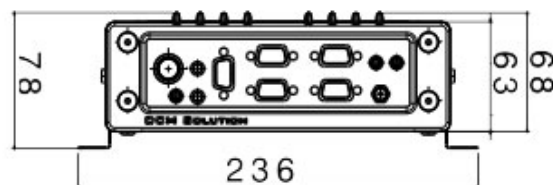
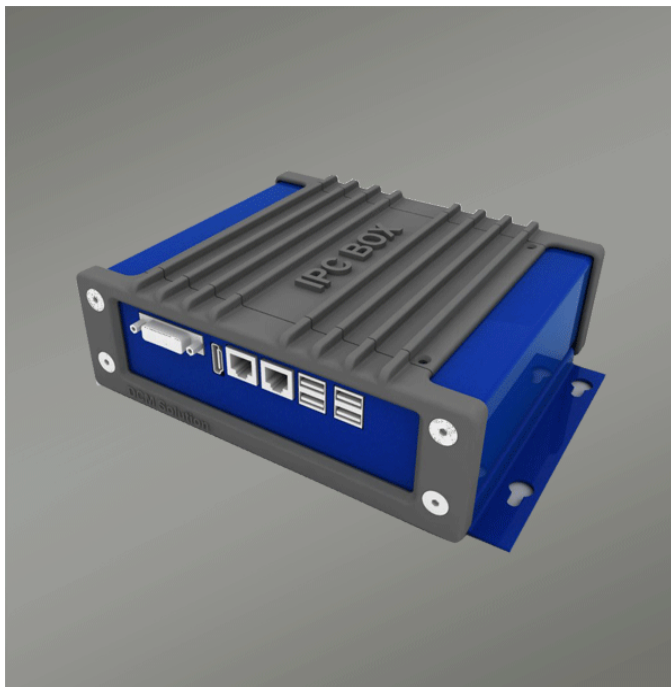

La información del documento, ilustraciones y especificaciones, son confiables a la fecha de su publicación pero está sujeta a cambios sin notificación previa.