

MC400HD

Molinete Heavy Duty

Molinete (Torniquete) reforzado diseñado especialmente para uso en transporte público y estadios.

Características principales

- Uso intensivo
- Diseño estético y ergonómico
- A prueba de polvo y derrame de líquidos
- Sistema amortiguado
- Sentido de paso configurable
- Estructura metálica
- Alta resistencia a golpes y vibraciones
- Bajo mantenimiento
- Sistema antivandálico
- Alimentación en Baja Tensión
- Indicadores luminosos de paso
- Diseñado especialmente para uso en transporte



Opcionales

- Acceso Bidireccional
- Rotor siempre trabado
- Sistema Antipánico Autosuficiente (SAA)
- Pictogramas
- Lector de tarjetas sin contacto o de código de barras
- Display
- Buzón de tarjetas























Modelos

MC400HD Molinete unidireccional con rotor siempre libre

GV400HD Gabinete fin de línea

MC400HD

Especificaciones

Aplicación	 Transporte	Material de aspas	 acero inoxidable
Ancho de paso	 500 mm	Diámetro del tubo	 38 mm
Altura obstáculo	 800 mm	Alimentación	 12Vdc
Superficie total	 730 x 1260 mm	Alim. lógica	 12 Vdc
Dimensiones	 1000 x 230 x 1250 mm	Interface	 Contacto seco
Flujo de pasajeros	 20 pasos/minuto	MCBF	 1.000.000 ciclos
Amortiguación	 amortiguador hidráulico	Peso	 20 Kg
Material gabinete	 acero inoxidable	Grado protección	 IP31
Espesor de chapa	 1,5 mm	Temp. operación	 0°C ~ 50°C
Terminación	 Pulido	Temp. de almacén	 -10°C ~ 55°C
Cantidad de aspas	 3	Humedad relativa	 95% sin condensación

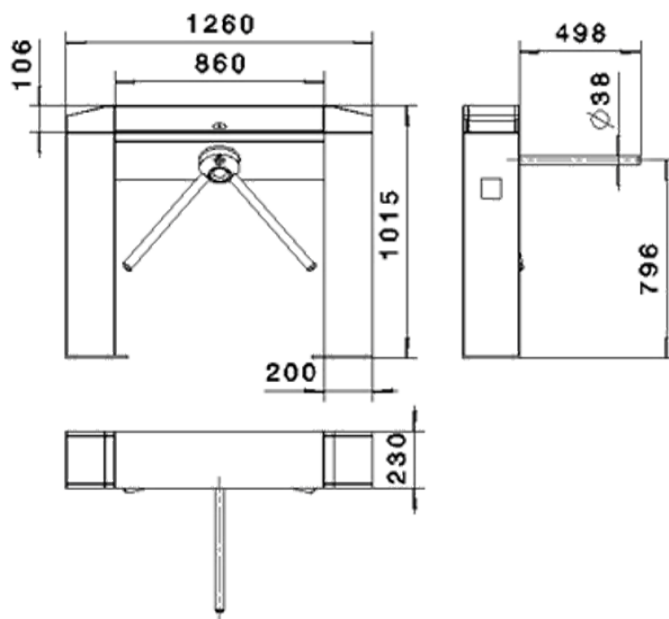

La información del documento, ilustraciones y especificaciones, son confiables a la fecha de su publicación pero está sujeta a cambios sin notificación previa.