

MC200

Molinete compacto

Molinete (Torniquetes) compacto para ser instalado en espacios reducidos.

Características principales

- Uso intensivo
- Diseño estético y ergonómico
- A prueba de polvo y derrame de líquidos
- Sistema amortiguado
- Sentido de paso configurable
- Estructura metálica
- Alta resistencia a golpes y vibraciones
- Bajo mantenimiento, Sistema antivandálico
- Alimentación en Baja Tensión
- Indicadores luminosos de paso



Opcionales

- Acceso Bidireccional
- Rotor siempre trabado
- Sistema Antipánico Autosuficiente (SAA)
- Lector de tarjetas sin contacto
- Lector de código de barras
- Display























Modelos

MC200

Molinete unidireccional con rotor siempre libre

MC200

Especificaciones

Aplicación	 Oficina	Material de aspas	 acero inoxidable
Ancho de paso	 500 mm	Diámetro del tubo	 38 mm
Altura obstáculo	 800 mm	Alimentación	 12Vdc
Superficie total	 755 x 790 mm	Alim. lógica	 12 Vdc
Dimensiones	 950 x 255 x 350 mm	Interface	 Contacto seco
Flujo de pasajeros	 20 pasos/minuto	MCBF	 1.000.000 ciclos
Amortiguación	 amortiguador hidráulico	Peso	 20 Kg
Material gabinete	 acero SAE1010 y tapa	Grado protección	 IP31
Espesor de chapa	 1,5 mm	Temp. operación	 0°C ~ 50°C
Terminación	 Pintado Polyester-Epoxi	Temp. de almacén	 -10°C ~ 55°C
Cantidad de aspas	 3	Humedad relativa	 95% sin condensación

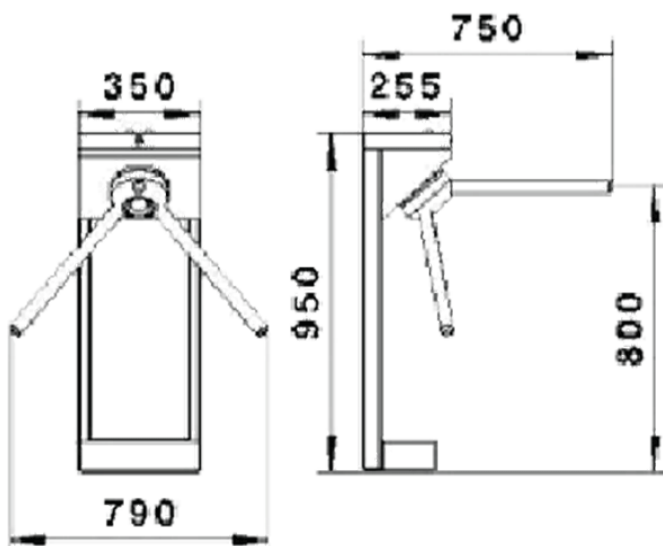

La información del documento, ilustraciones y especificaciones, son confiables a la fecha de su publicación pero está sujeta a cambios sin notificación previa.