

GM-GS

GM210

Puerta manual para retail

Puerta para encausar flujo de personas en establecimientos comerciales.

Características principales

- Uso intensivo
- Para interior o semi intemperie
- Diseño elegante y ergonómico
- A prueba de polvo y derrames
- Acceso unidireccional
- Sentido de paso izquierdo o derecho
- Alta resistencia a golpes y vibraciones
- Bajo mantenimiento
- Sistema amortiguado
- Mamparas indicadoras
- Sistema antivandalismo

Opcionales

- Estructura pintada

Modelos

GM210



















Puerta manual para retail



GM-GS

GM210

Especificaciones

Tipo de Activación	 Manual	Flujo de pasajeros	 20 pasos/minuto	Flujo de abastecimiento	 50 l/min sin condensación
Ancho de paso	 900 mm	Material gabinete	 acero inoxidable	Alimentación	 12Vdc
Altura obstáculo	 890 mm	Espesor de chapa	 1,5 mm	Alim. lógica	 12 Vdc
Superficie total	 1000x1000 mm	Terminación	 Pulido	Interface	 Contacto seco
Dimensiones	 1000x1000x100 mm			MCBF	 1.000.000 ciclos
				Peso	 53 Kg
				Grado protección	 IP31
				Temp. operación	 0°C ~ 50°C
				Temp. de almacén	 -10°C ~ 55°C

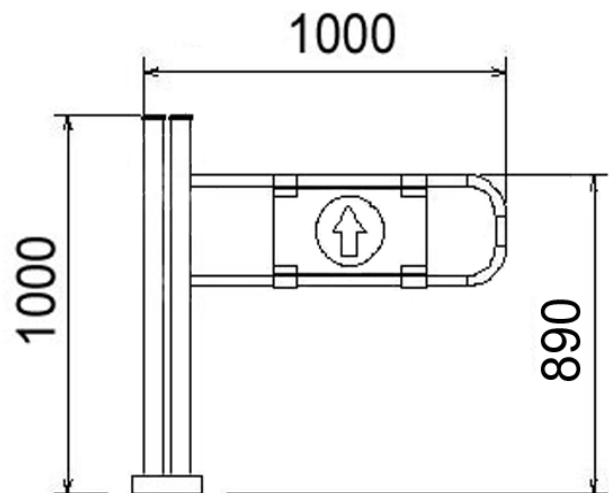

La información del documento, ilustraciones y especificaciones, son confiables a la fecha de su publicación pero está sujeta a cambios sin notificación previa.